

Earnings Release Conference FY2021 (April 2021 to March 2022)

April 28, 2022

Murata Manufacturing Co., Ltd.



Financial Results of FY2021

Financial Results

- Net sales were 1,812.5 billion yen, up 11.2% year on year. Sales of mainly capacitors and lithium-ion secondary batteries rose. Operating income was 424.1 billion yen, also up 35.4% year on year. Both net sales and operating income marked a record high.
- Net sales and operating income increased 2.4% and 3.4% respectively, compared with the forecast. Net sales exceeded the forecast primarily for automotive electronics and EDP. Operating income also outperformed the forecast primarily due to productivity gains from higher capacity utilization and the impact of the depreciation of the yen.

Shareholder returns

- The Company plans to pay a year-end dividend of 70 yen per share for FY2021, an increase of 5 yen per share from the previous forecast. (An annual dividend of 130 yen per share)

Projected Financial Results for FY2022

Projected Financial Results

- The Company plans to increase net sales 6.5% year on year. The Company expects higher sales of mainly components for automotive electronics and stronger sales of lithium-ion secondary batteries for power tools.
- Operating income is projected to increase 3.8% year on year. The Company plans to increase profits, based on the effect of the depreciation of the yen and rationalization, despite the expectation of a decline in product selling prices and a rise in fixed costs.

Capital expenditures

- The Company plans a capital expenditure of 240.0 billion yen, up 87.2 billion yen from the previous term, as investments in expanding and reinforcing production capacity in preparation for the medium-term growth of demand for parts.

Shareholder returns

- The Company plans to pay an annual dividend of 150 yen per share, an increase of 20 yen per share from the previous year.
- Purchase of the Company's own shares up to 80 billion yen.



Financial Results of FY2021

From April 2021 to March 2022
Consolidated Basis

Quarterly Financial Results

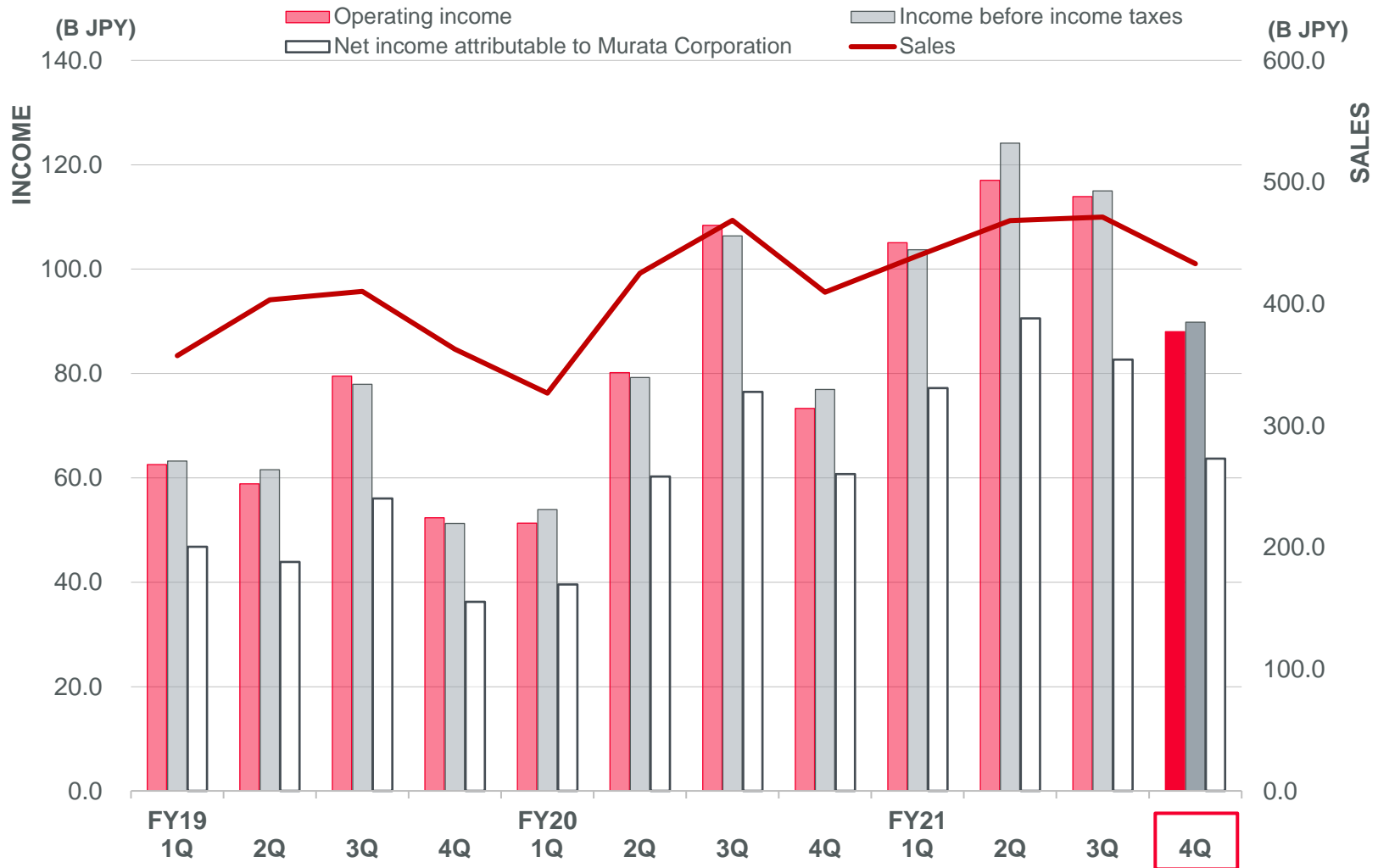

Financial Results Overview

	FY2020		FY2021		Y on Y Change	
	(B JPY)	(%)	(B JPY)	(%)	(B JPY)	(%)
Net sales	1,630.2	100.0	1,812.5	100.0	+182.3	+11.2
Operating income	313.2	19.2	424.1	23.4	+110.8	+35.4
Income before income taxes	316.4	19.4	432.7	23.9	+116.3	+36.8
Net income attributable to Murata Corporation	237.1	14.5	314.1	17.3	+77.1	+32.5
ROIC (pre-tax basis) (%)	18.5		22.6			
Average exchange rates yen/US dollar	106.06		112.38			

- Net sales increased since sales of capacitors significantly rose for computers, peripheral devices and automotive electronics, and sales of lithium-ion secondary batteries grew for power tools, in addition to the effect of the depreciation of the yen.
- Profits increased mainly due to productivity gains from a higher capacity utilization rate, cost reductions and the effect of the depreciation of the yen despite a rise in production-related costs resulting from greater production output.
- Net sales and incomes of each type marked record highs.

Quarterly Sales, Order and Backlog

- Orders received for capacitors increased quarter to quarter for automotive electronics. The Company's book-to-bill ratio as a whole exceeded 1, and the order backlog rose.
- The order backlog set a new highest record. However, the increase includes some resulting from the impact of currency fluctuations as the yen depreciated sharply at the end of March.

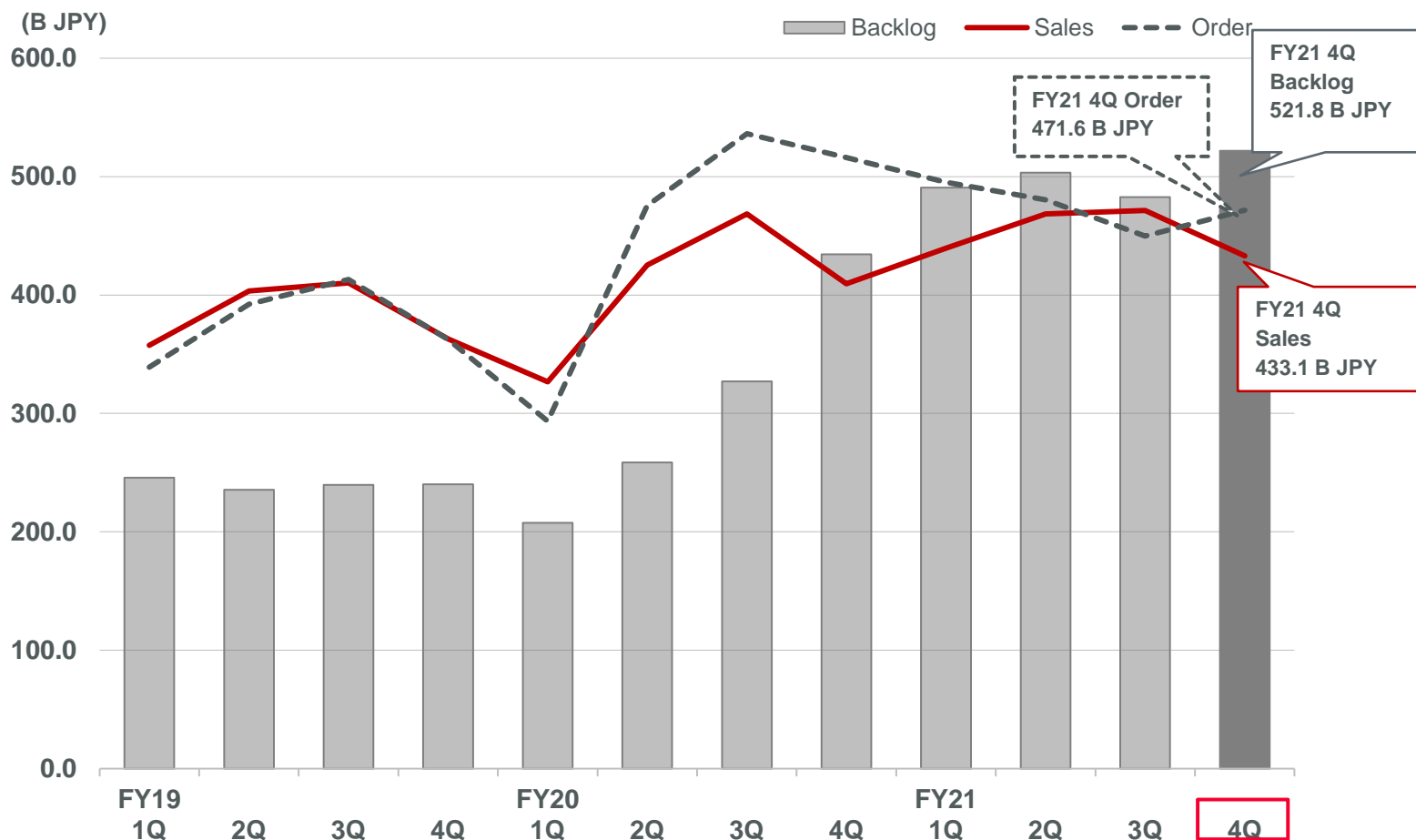

Sales by Product

	FY2020		FY2021		Y on Y Change	
	(B JPY)	(%)	(B JPY)	(%)	(B JPY)	(%)
Capacitors	626.5	38.5	785.3	43.4	+158.7	+25.3
Piezoelectric Components	129.3	8.0	138.4	7.7	+9.1	+7.0
Other Components	387.6	23.8	460.4	25.4	+72.8	+18.8
Modules	484.1	29.7	425.6	23.5	(58.5)	(12.1)
Net sales	1,627.6	100.0	1,809.6	100.0	+182.0	+11.2

Sales by Product [FY2020 to FY2021]

Capacitors +25.3%	<p>Multilayer Ceramic Capacitors(MLCCs) : Sales increased significantly not only for PCs, against the background of demand for remote work and online education, but also for car electronics due to progress in electrification of automobiles and the accumulation of parts inventory by clients.</p>
Piezoelectric Components +7.0%	<p>Piezoelectric sensors : Sales increased for HDDs.</p> <p>Ceramic resonators : Sales expanded for a broad range of applications.</p> <p>SAW Filters : Sales increased for IoT devices.</p>
Other Components +18.8%	<p>Lithium-Ion secondary batteries : Sales increased significantly for power tools.</p> <p>Inductors : Sales increased for PCs and automotive electronics.</p>
Modules (12.1%)	<p>Connectivity modules : sales decreased for smartphones due to the restructuring of product portfolios.</p> <p>Multilayer resin substrates : Sales decreased for communication devices.</p>

Sales by Application

	FY2020		FY2021		Y on Y Change	
	(B JPY)	(%)	(B JPY)	(%)	(B JPY)	(%)
AV	71.9	4.4	71.5	3.9	(0.4)	(0.6)
Communication	804.9	49.5	779.2	43.1	(25.7)	(3.2)
Computers and Peripherals	291.5	17.9	360.4	19.9	+68.9	+23.6
Automotive Electronics	273.2	16.8	336.3	18.6	+63.1	+23.1
Home Electronics and Others	186.1	11.4	262.2	14.5	+76.1	+40.9
Net sales	1,627.6	100.0	1,809.6	100.0	+182.0	+11.2

*Based on our estimate

Sales by Application [FY2020 to FY2021]

AV (0.6%)	<ul style="list-style-type: none"> • Sales of lithium-ion secondary batteries increased for digital cameras. However, sales of MLCCs decreased for set-top boxes.
Communication (3.2%)	<ul style="list-style-type: none"> • Sales of MLCCs for smartphones increased. • As a result of a revision to the business portfolio for the above application, sales of connectivity modules decreased. • Sales of RF modules also decreased.
Computers and Peripherals +23.6%	<ul style="list-style-type: none"> • Sales of MLCCs and inductors for PCs and servers increased significantly.
Automotive Electronics +23.1%	<ul style="list-style-type: none"> • Sales of MLCCs increased significantly due to demand generated by progress in electrification of automobiles and the accumulation of parts inventory by clients. • Sales of electromagnetic interference (EMI) suppression filters and inductors also increased.
Home Electronics and Others +40.9%	<ul style="list-style-type: none"> • Sales of lithium-ion secondary batteries for power tools increased significantly. • Sales of MLCCs for distributors increased.

Segment Information

		FY2020		FY2021		Y on Y Change	
		(B JPY)	(%)	(B JPY)	(%)	(B JPY)	(%)
Components	Total Revenues	1,175.4	100.0	1,416.6	100.0	+241.2	+20.5
	Segment income	313.0	26.6	452.6	32.0	+139.6	+44.6
Modules	Total Revenues	484.1	100.0	425.6	100.0	(58.5)	(12.1)
	Segment income	54.3	11.2	38.5	9.1	(15.8)	(29.0)
Others	Total Revenues	61.1	100.0	61.3	100.0	+0.2	+0.3
	Segment income	7.8	12.7	6.9	11.3	(0.8)	(10.7)
Corporate and eliminations	Total Revenues	(90.4)	-	(90.9)	-	(0.5)	-
	Corporate expenses	(61.8)	-	(74.0)	-	(12.2)	-
Consolidated	Total Revenues	1,630.2	100.0	1,812.5	100.0	+182.3	+11.2
	Operating income	313.2	19.2	424.1	23.4	+110.8	+35.4

- **Components** Both sales and profit increased due to a considerable rise in sales of capacitors and inductors.
- **Modules** Sales and profit decreased as there were lower sales for connectivity modules due to the revision of the business portfolio, and there were weaker sales primarily of MetroCirc and high-frequency modules.

Breakdown of Operating Income Changes [FY2020 to FY2021]

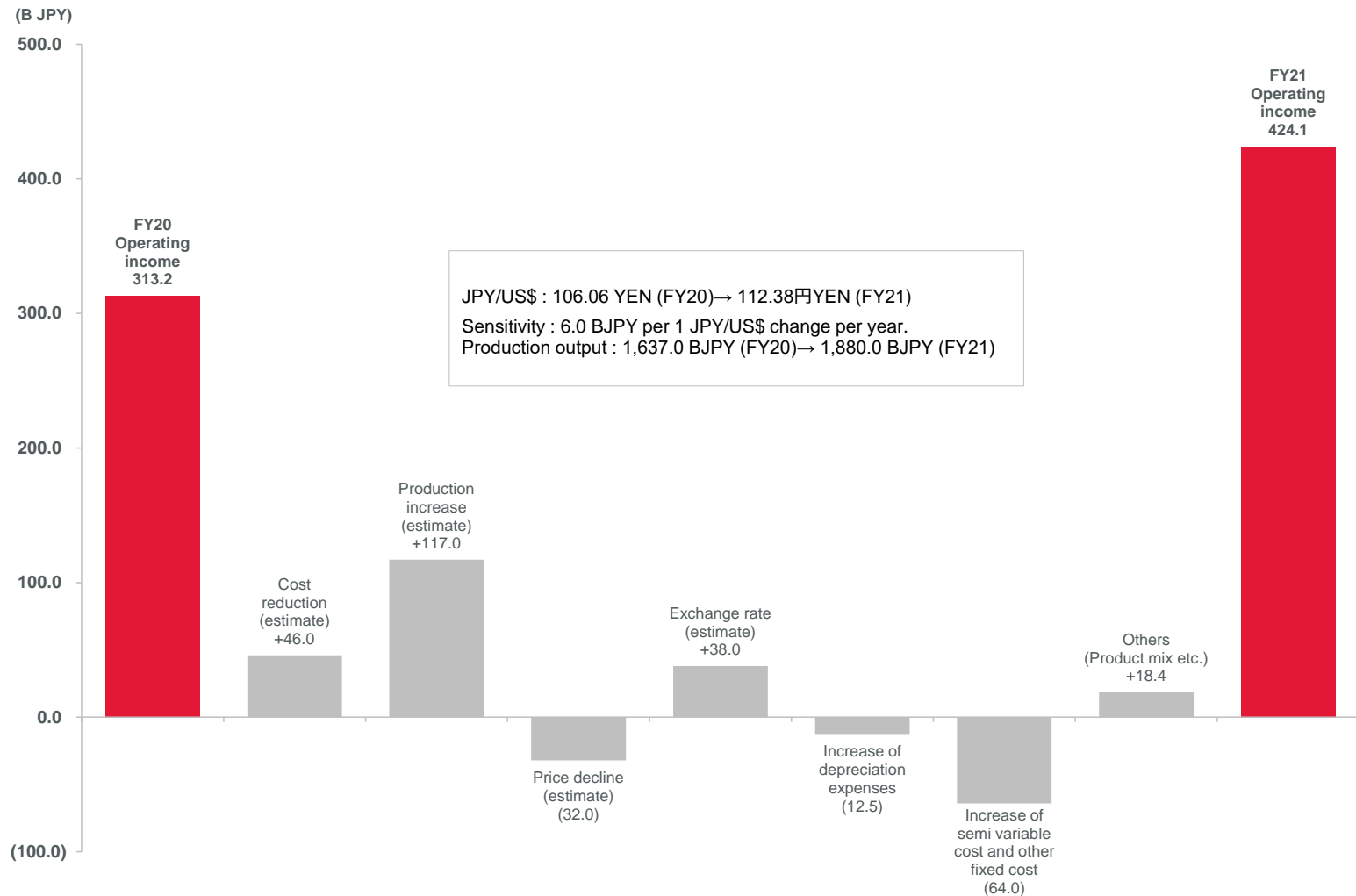

*“Production increase” is calculated on the basis of production output excluding the effect of sales price reductions and exchange rate fluctuations.

*Changes in semi-variable costs and fixed costs include the impact of temporary expenses.

Cash Flows

	FY2020	FY2021	Y on Y Change
	(B JPY)	(B JPY)	(B JPY)
Operating activities	373.6	421.5	+47.9
Investing activities	(150.3)	(212.3)	(62.0)
Financing activities	(118.2)	(117.5)	+0.7
Effect of exchange rate changes	0.3	12.7	+12.4
Cash and cash equivalents	407.7	512.1	+104.4
Free Cash Flows	223.3	209.2	(14.1)
Capital expenditures	(199.9)	(150.5)	+49.3
Depreciation and amortization	143.1	155.6	+12.5

- Operating cash flow increased thanks to a substantial increase in profits compared with the same period of the previous year.
- The cash consideration for the acquisition of Eta Wireless, Inc. and Resonant Inc. (48.8 billion yen) was reported as a cash flow from investing activities.
- There was a decrease in corporate bonds (40.0 billion yen) in cash flows from financing activities.



Projected Financial Results for FY2022

(From April 2022 to March 2023)

Projected Financial Results for FY2022

	FY2021 Actual		1st Half		2nd Half		FY2022 Projections		Change	
	(B JPY)	(%)	(B JPY)	(B JPY)	(B JPY)	(%)	(B JPY)	(%)	(B JPY)	(%)
Net sales	1,812.5	100.0	952.0	978.0	1,930.0	100.0	+117.5	+6.5		
Operating income	424.1	23.4	209.0	231.0	440.0	22.8	+15.9	+3.8		
Income before income taxes	432.7	23.9	210.0	232.0	442.0	22.9	+9.3	+2.1		
Net income attributable to Murata Corporation	314.1	17.3	154.0	170.0	324.0	16.8	+9.9	+3.1		
ROIC (pre-tax basis) (%)	22.6				21.6		(1.0)			
Average exchange rates yen/US dollar	112.38				120.00					

- Sales of capacitors, inductors and EMI suppression filters are expected to increase for automotive electronics, and moreover, sales of lithium-ion secondary batteries are forecast to grow for power tools. Additionally, there will be the effect of the depreciation of the yen. Based on these, net sales are planned to increase year on year.
- The plan is to increase profits year on year mainly due to the effect of the depreciation of the yen and cost reductions despite negative factors such a decline in product selling prices and a rise in fixed costs.

Recognition of Business Environment

Assumptions for projected financial results

Risks not factored into projected financial results

Sales

- Recovery will start from Q2 in demand for smartphone manufacturers in Greater China
- Supply chain disruptions due to lockdowns in China will return to normal in Q2
- There will be no reduction of BCP inventory by customers
- Decline in the number of automobiles produced due to the Ukraine crisis (Decrease of 2.5 million units)

- Delay in the recovery of demand for smartphone manufacturers in Greater China
- Lingering impact of lockdowns in China
- Further decline in the number of sets produced due to prolonged crisis in Ukraine
- Decline in consumers' purchasing appetite due to a rise in prices

Productions

- Supply chain disruptions due to lockdowns in China will return to normal in Q2
- There will be no constraints on production caused by incidents other than lockdowns in China & other countries.

- Decline in the operational rate of the Company's plants due to the persistent effect of lockdowns in China
- Decline in the operation rate of the Company's plants due to a tight electricity supply in Japan

Costs

- Reflection of cost rises resulting from a surge in raw material prices and a rise in electricity rates (Estimates based on the situation as of the end of March)

- Further surge in raw material prices
- Rise in unit prices of fuel cost adjustment in electricity rates
- Extended period of a surge in logistics costs

Projection of Demand

	FY2021 Actual	FY2022 Projections	Change	
Smart phones (units)	1,360 M	1,370 M	+1%	→
therein 5G smartphones	560 M	750 M	+32%	↗
PCs (units)	500 M	480 M	(4%)	↘
Vehicles (units)	76 M	84 M	+10%	↗
therein xEV	16 M	24 M	1.5 times	↗

* Vehicles are based on the number of units produced.

- **Smartphones** Smartphone manufacturers in the Greater China are expected to recover, but overall market growth is expected to slow.
- **PCs** The number of units will decline as demand for remote work and online education wears off.
- **Vehicles** The quantity of vehicles produced is expected to grow as semiconductor shortages are solved. In particular, large growth is expected in xEV.

Change in Segment for Disclosure

Current Segment (~FY2021)

Segment	Sales Category	Main products
Components	Capacitors	Multilayer ceramic capacitors (MLCCs)
	Piezoelectric Components	SAW filters
		Piezoelectric sensors
		Ceramic resonators
	Other Components	Inductors
		EMI filters
		Lithium ion secondary batteries
		Connectors
		Sensors
		Thermistors
Modules	RF modules	
	Multilayer ceramic devices	
	Connectivity modules	
	Multilayer resin substrates	
	Power supplies modules	
	Solutions	
	Others	Machinery manufacturing
Sales of software		

New Segment (FY2022~)

Segment	Sales Category	Main products
Components	Capacitors	Multilayer ceramic capacitors (MLCCs)
	Inductors and EMI filters	Inductors EMI filters
Devices/ modules	High-Frequency Device and Communications Module	SAW filters
		RF modules
		Multilayer ceramic devices
		Connectors
		Connectivity modules
		Multilayer resin substrates
Others	Battery and Power supply	Lithium ion secondary batteries Power supplies modules
	Functional Device	Sensors Timing Devices (Resonators)
Others		Solutions
		Machinery manufacturing
		Sales of software

- From the fiscal year ending March 2023, Segment Information will be changed to align with the 3-layered portfolio.
- We will connect the enhancement of transparency in management to promotion of proactive dialogue with stakeholders and of autonomous and decentralized organizational operation.

Projected Sales by Product

	FY2021 Actual (B JPY)	FY2022 Projections (YoY growth ratio)	FY2022 Projections (HoH growth ratio)
Capacitors	788.5	+11%	+6%
Inductors and EMI filters	195.8	+10%	Flat
Components	984.3	+11%	+5%
High-Frequency Device and Communications Module	528.2	(10%)	(3%)
Battery and Power supply	180.4	+27%	+5%
Functional Device	106.4	+10%	Flat
Devices/Module	815.0	+1%	Flat
Total	1,809.6	+6%	+3%

Please refer to page 50 for the quarterly results for fiscal 2021.

Projected Sales by Product [FY2021 to FY2022]

Capacitors +11%	<p>MLCCs : Sales are planned to grow due to an increase in the number of parts, resulting from a greater number of vehicles produced and progress in the electrification of automobiles, as well as a rise in the number of units of 5G smartphones.</p>
Inductors and EMI filters +10%	<p>Inductors / Electromagnetic interference suppression filters: : Sales are planned to increase as demand grows due to the increase in the number of vehicles produced, the progress of electrification, and the increase in the number of 5G smartphones.</p>
High-Frequency Device and Communications Module (10%)	<p>Connectivity modules : Sales are planned to decline due to the continued review of the business portfolio.</p> <p>RF modules : Sales are expected to decline for smartphones.</p>
Battery and Power supply +27%	<p>Lithium-Ion secondary batteries : Sales are planned to rise in expectation that brisk demand for power tools will continue.</p>
Functional Device +10%	<p>Sensors / Timing Devices : Sales are planned to grow due to an increase in the number of parts in smartphones, and progress in the electrification of automobiles.</p>

Change in Sales by Application Category

~FY2021

Sales by Application	Main applications
AV	TV, Video Game
	Digital Camera
Communication	Smartphone
	Wearable Appliance
	Base Station
Computers and Peripherals	Electronic Data Processing
	Industrial equipment
Automotive Electronics	Automobile
	Motor cycle
Home Electronics and Others	Home Electrical Appliance
	Others

FY2022~

Sales by Application	Main applications
Communication	Smartphone
	Wearable Appliance
	Base Station
Mobility	Automobile
	Motor cycle
Computers	Electronic Data Processing
Home Electronics	TV, Video Game
	Digital Camera
	Power tool
	Home Electrical Appliance
Industry and Others	Industrial equipment
	Others

Sales by Application Category will be revised to coincide with the change of Segment Information from the fiscal year ending March 2023.

Projected Sales by Application

	FY2021 Actual (B JPY)	FY2022 Projections (YoY growth ratio)	FY2022 Projections (HoH growth ratio)
Communication	779.2	+1%	+1%
Mobility	336.3	+21%	+9%
Computers	297.5	+2%	+6%
Home Electronics	183.2	+23%	(3%)
Industry and Others	213.4	(4%)	+1%
Total	1,809.6	+6%	+3%

*Based on our estimate

Please refer to page 50 for the quarterly results for fiscal 2021.

Projected Financial Results for FY2022

	FY2021 Actual	FY2022 Projections
Depreciation and amortization	155.6 B JPY	166.0 B JPY
R & D expenses	111.3 B JPY	116.0 B JPY
Capital expenditures	152.8 B JPY	240.0 B JPY
Average exchange rate (JPY/USD)	112.38	120.00

[Exchange rate sensitivity (per 1 JPY/US\$ change per year)]

Net sales FY2022 : 11.0 BJPY

Operating income FY2022 : 6.0 BJPY

Breakdown of Operating Income Changes [FY2021 to FY2022]

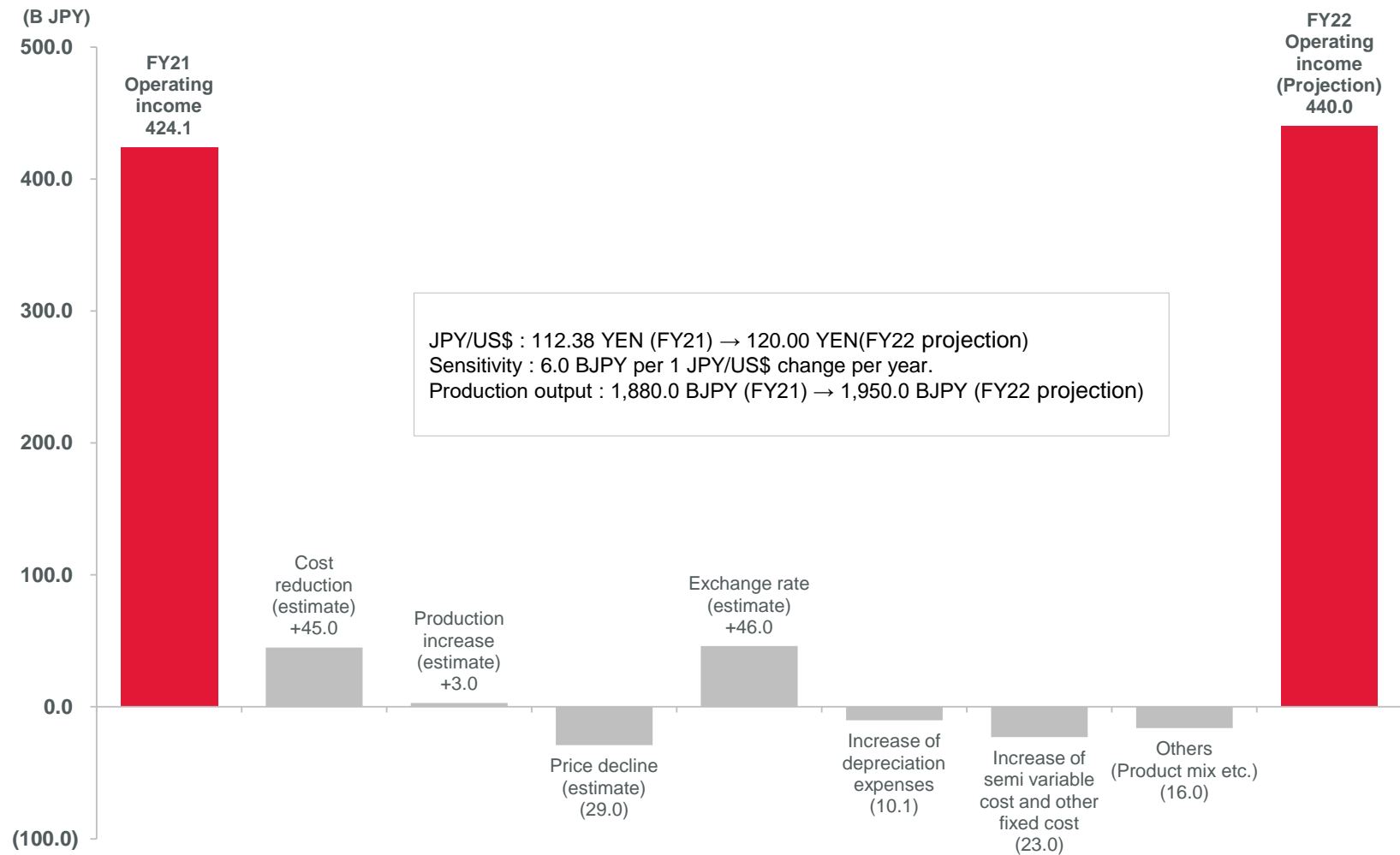

*“Production increase” is calculated on the basis of production output excluding the effect of sales price reductions and exchange rate fluctuations.

*Changes in semi-variable costs and fixed costs include the impact of temporary expenses.

Projected Financial Results for FY2022

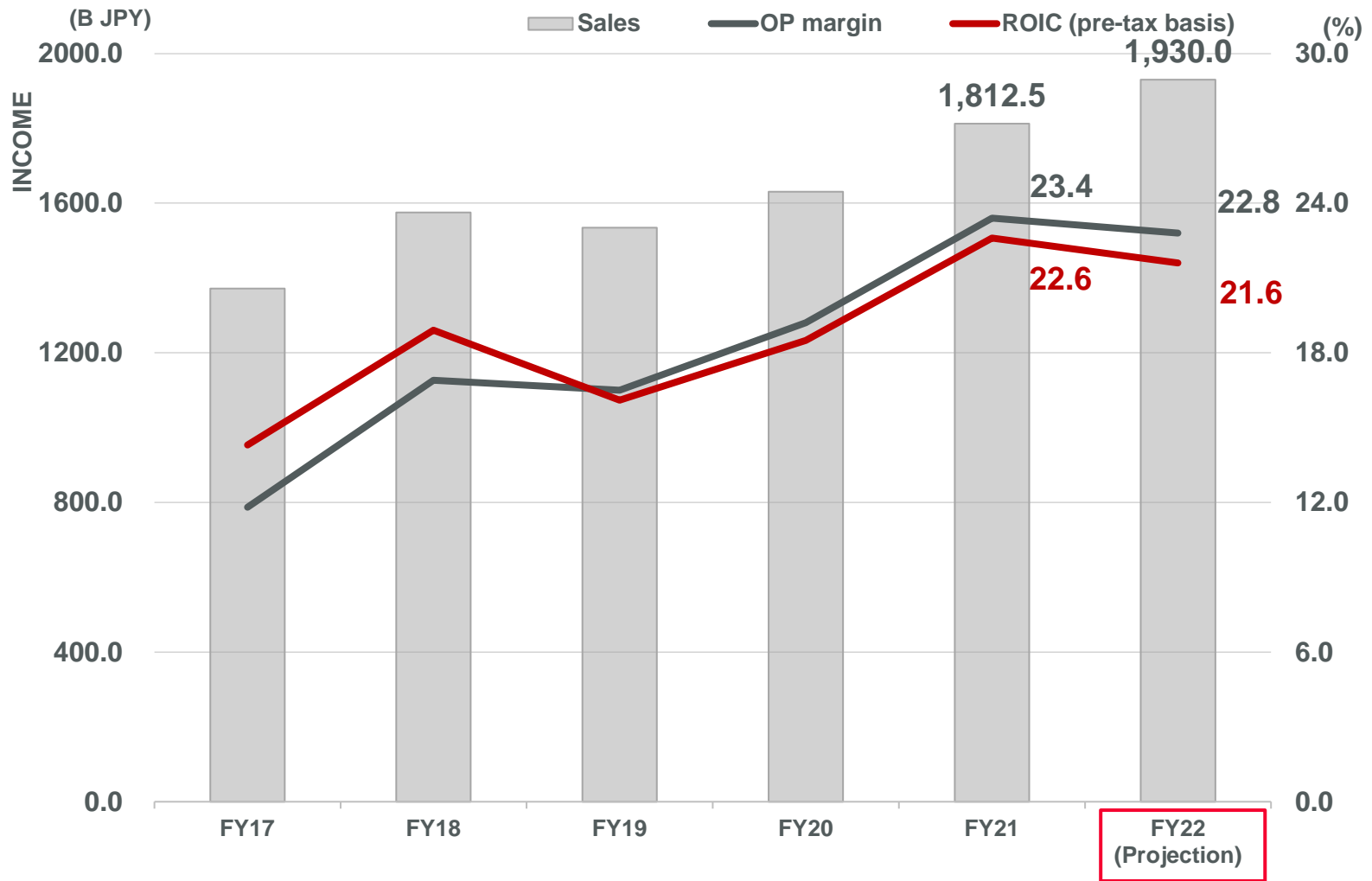

Quarterly Financial Results

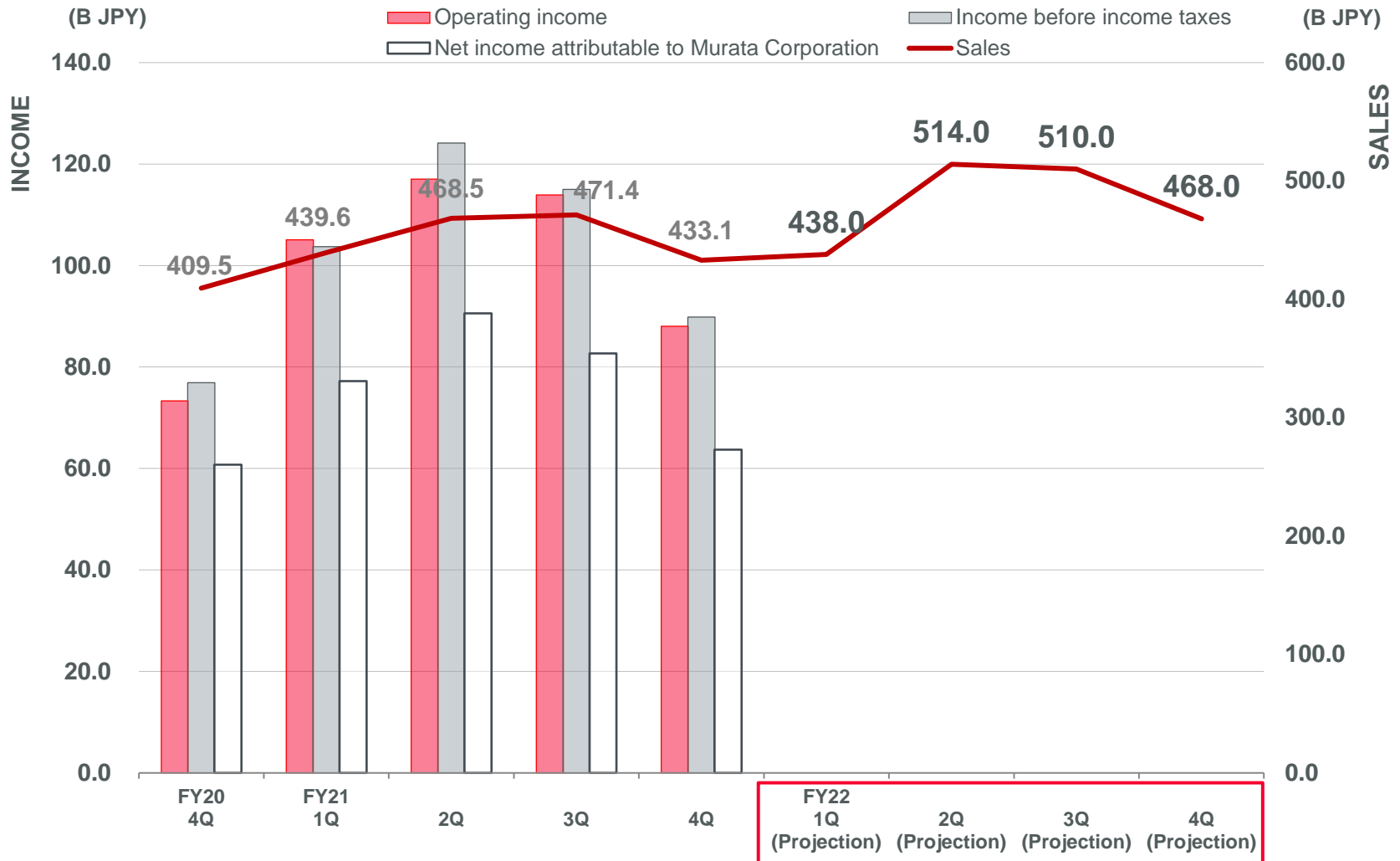

Shareholder return



Dividends per Share

- FY2022 (Year Ending March 31, 2023) projected annual dividends per share
- 150 JPY per share
- (Interim: 75 JPY per share, Year-end: 75 JPY per share)
*20 yen increase of annual dividend per share

- FY2021 (Year Ending March 31, 2022) annual dividends per share
130 JPY per share
(Interim: 60 JPY per share, Year-end: 70 JPY per share)
*The year-end dividend has been increased by 5 yen per share from the previous forecast.

Note: The above projections are based on our view of the current business environment and our projections for FY2022.

Share Buyback

Purchase of our own shares was resolved at the meeting of the Board of Directors on April 28, 2022.

- Number of shares to be purchased : up to 16 million shares (2.50% of shares outstanding (excluding treasury stock))
- Total amount of purchase costs of shares : Up to 80 billion yen
- Period of acquisition : From May 2, 2022 to October 31, 2022
- Purpose : To improve capital efficiency and enable a flexible financial strategy.

Return to Shareholders

- **Dividend** As a stable increase in dividends is our basic policy, we aim to achieve DOE (Dividend on equity ratio) of 4% or higher over the medium term with reference to dividend payout ratio of approximately 30%.
- **Share buyback** As a means of returning profits to shareholders, we implement share buybacks in a timely manner to improve capital efficiency.

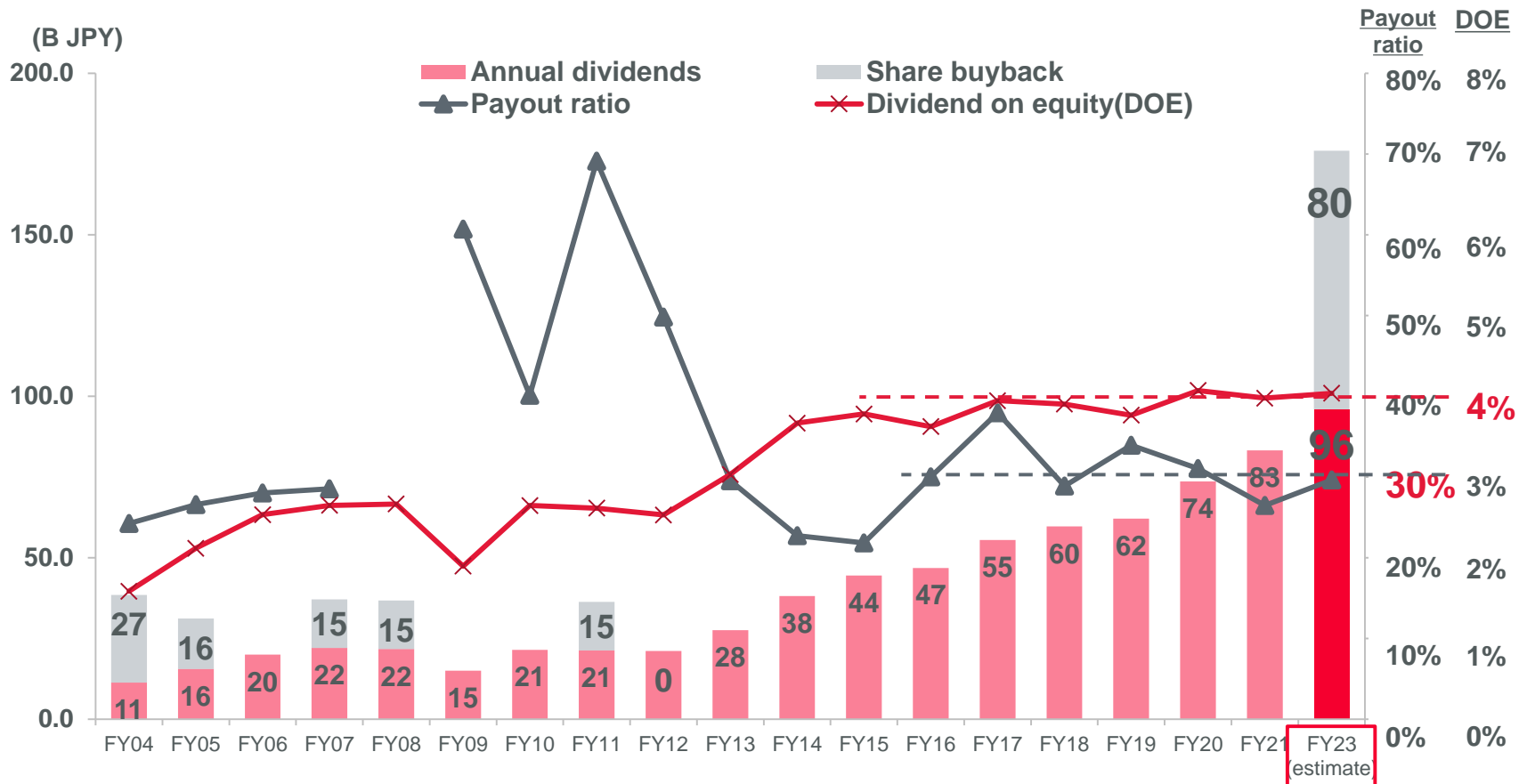

Cash Flows

- Cash flow from operating activities is expected to increase for FY2022.
- We plan to increase capital expenditure and step up shareholder return including dividend increase and Share Buyback.

(B JPY)

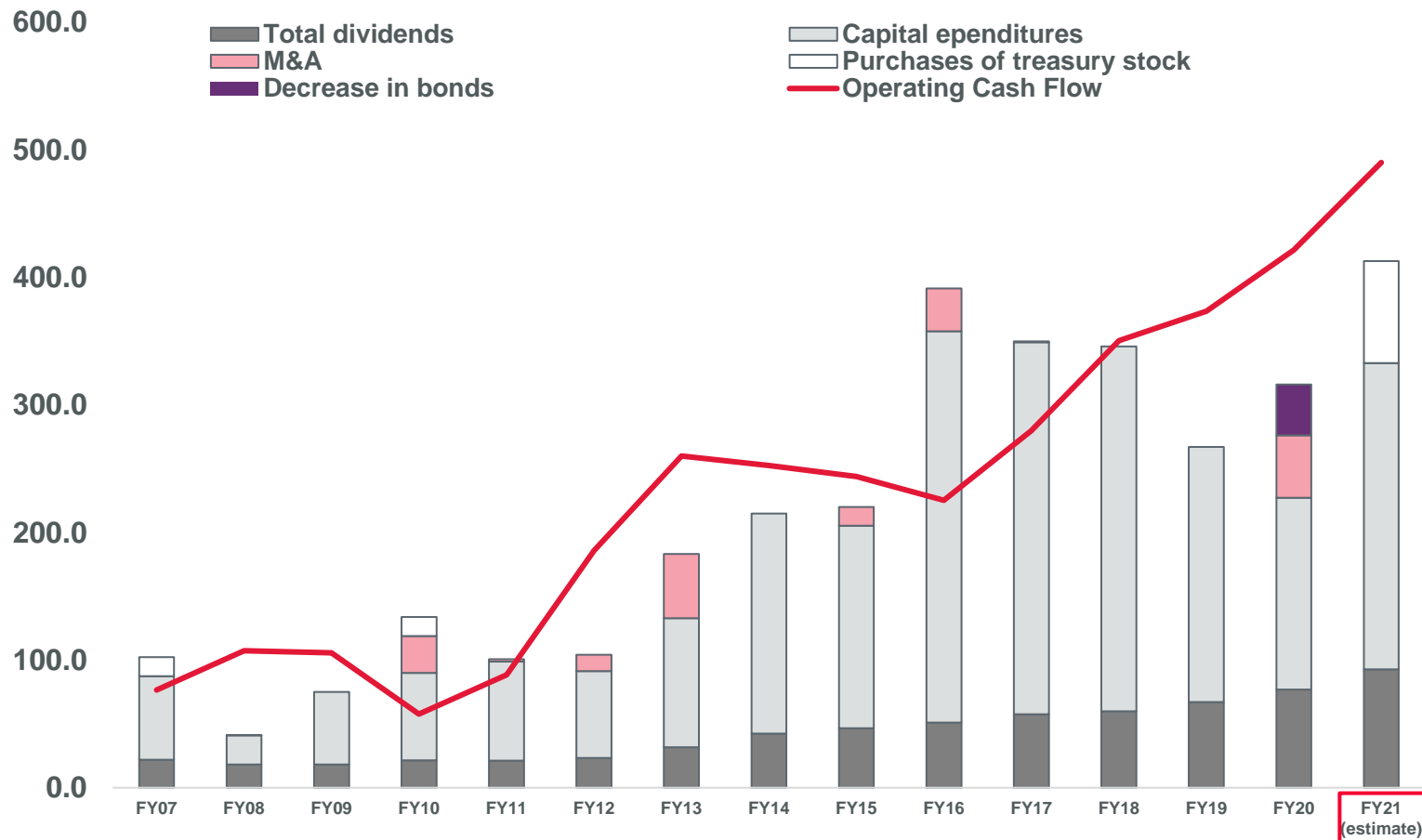

Topics



Acquisition of Resonant Inc.

Outline

- Acquisition date : March 2022
- Consideration for acquisition : Approximately 35 billion yen
- Resonant Inc.
 - Resonant's proprietary XBAR technology*
*Filter technology using piezoelectric monocrystal thin film that can handle high frequencies and has high power resistance
 - This technology will be critical in achieving reliable, high-speed wireless communications for standards such as 5G and beyond.



Effect of acquisition

- Expand and reinforce the product lineup of high-frequency filters
- In addition, contribute to the growth of the high-frequency device business as a differentiated technology of high-frequency filters



Acquisition of differentiated technologies in the High-Frequency Device and Communications Module and establishment of competitive advantages

Acquisition of Resonant Inc.

Features of XBAR technology

- **High performance in high frequencies and wide bandwidths**

Can demonstrate superiority in frequency-filtering characteristics (high attenuation, low loss, steepness) in high-frequency bands and wide bandwidths, which are areas with high technical difficulty levels.

- **Strong affinity with SAW filter technology**

Strong synergies with existing technologies. The Company's production capacity of SAW filters, which is the largest in the industry, can be also utilized.

Filters and their applicable frequency bands

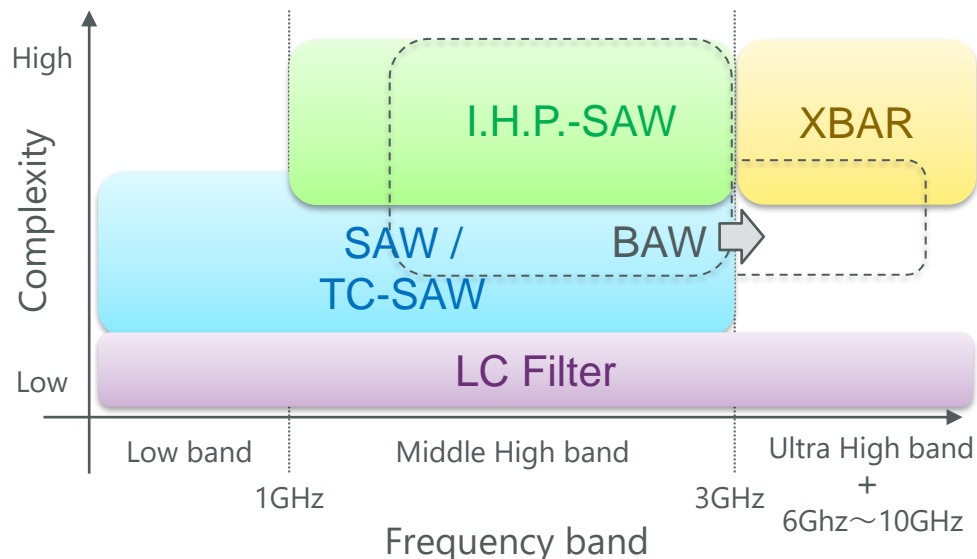

Needs

5G and next-generation Wi-Fi® standards are becoming more common

Communication terminals will be required to receive high-frequency signals accurately

There will be a growing need for high-performance, wide-bandwidth, high-frequency filters.

Expanding opportunities for XBAR

M&A and Acquired Technologies Related to High-Frequency Devices

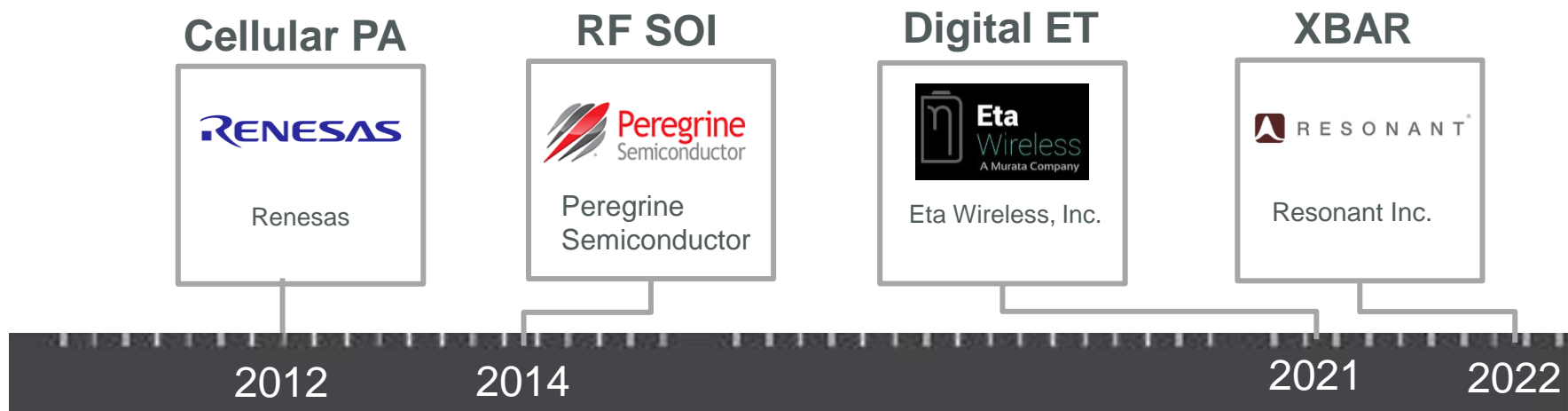

2012: Renesas

Acquired the cellular power amplifier (PA) business. Ready to develop and manufacture PA built-in modules. Expanded and reinforced the product lineup.

2014: Peregrine Semiconductor

Ready to develop distinctive radio frequency (RF) silicon-on-insulator (SOI) (antenna switch and LNA). Capable of differentiating the Company's products from competitors in low loss

2021年: Eta Wireless

Acquired new technologies for reducing power consumption. Technology that will be crucial as the use of 5G/6G spreads. Planned to be launched for commercialization in FY2024

2022年: RESONANT

Acquired the XBAR technology that can handle higher frequencies and wider bandwidths. Ramped up the filter business for 5G and 6G. Scheduled for mass production in FY2023

Acquire necessary technologies in preparation for possible changes in the telecommunications market. Enhance differentiated technologies to capture growth opportunities. Aim to return to a growth path.

This report contains forward-looking statements concerning Murata Manufacturing Co., Ltd. and its group companies' projections, plans, policies, strategies, schedules, and decisions. These forward-looking statements are not historical facts; rather, they represent the assumptions of the Murata Group (the "Group") based on information currently available and certain assumptions we deem as reasonable. Actual results may differ materially from expectations due to various risks and uncertainties. Readers are therefore requested not to rely on these forward-looking statements as the sole basis for evaluating the Group. The Company has no obligation to revise any of the forward-looking statements as a result of new information, future events or otherwise.

Risks and uncertainties that may affect actual results include, but are not limited to, the following: (1) economic conditions of the Company's business environment, and trends, supply-demand balance, and price fluctuations in the markets for electronic devices and components; (2) price fluctuations and insufficient supply of raw materials; (3) exchange rate fluctuations; (4) the Group's ability to provide a stable supply of new products that are compatible with the rapid technical innovation of the electronic components market and to continue to design and develop products and services that satisfy customers; (5) changes in the market value of the Group's financial assets; (6) drastic legal, political, and social changes in the Group's business environment; and (7) other uncertainties and contingencies.

The Company undertakes no obligation to publicly update any forward-looking statements included in this report.

Thank you



Appendixes



Orders by Product

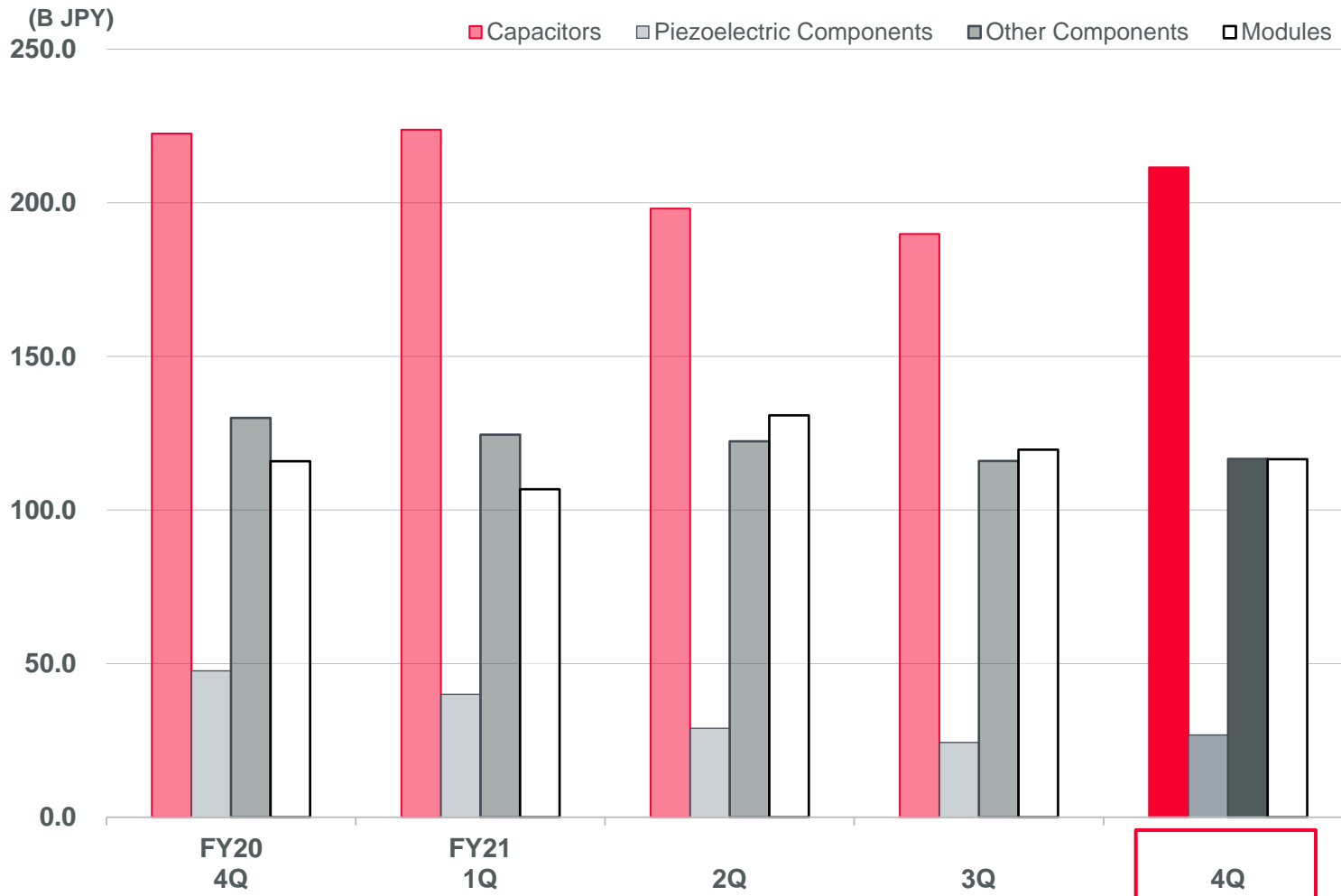

Financial Results Overview

[FY21 3rd Quarter to FY21 4th Quarter]

	FY2021 3rd Quarter		FY2021 4th Quarter		Q on Q Change	
	(B JPY)	(%)	(B JPY)	(%)	(B JPY)	(%)
Net sales	471.4	100.0	433.1	100.0	(38.3)	(8.1)
Operating income	113.9	24.2	88.0	20.3	(25.9)	(22.7)
Income before income taxes	115.0	24.4	89.8	20.7	(25.2)	(21.9)
Net income attributable to Murata Corporation	82.6	17.5	63.7	14.7	(19.0)	(22.9)

Breakdown of Operating Income Changes [FY21 3rd Quarter to FY21 4th Quarter]

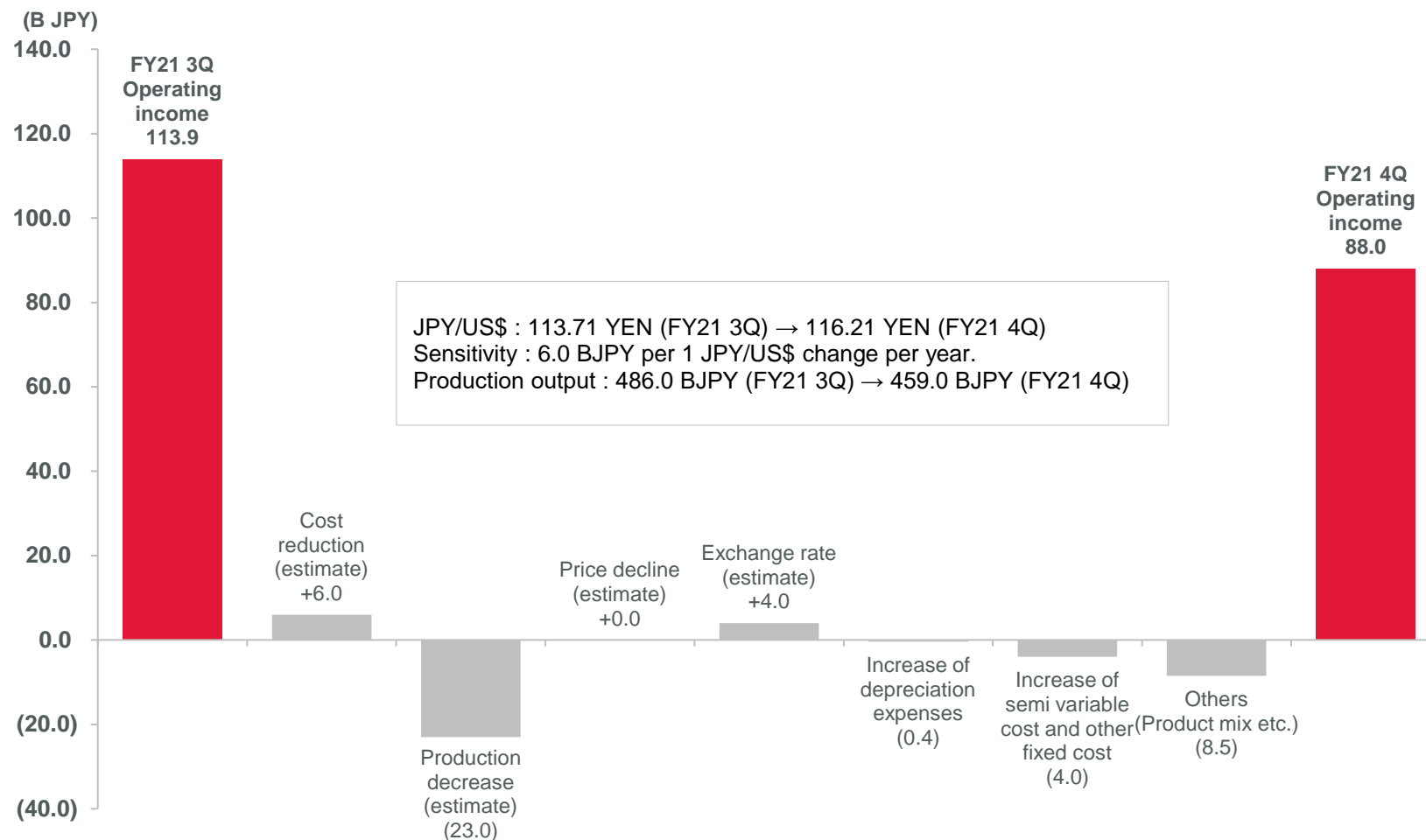

*"Production decrease" is calculated on the basis of production output excluding the effect of sales price reductions and exchange rate fluctuations.

*Changes in semi-variable costs and fixed costs include the impact of temporary expenses.

Financial Results Overview

[FY21 Projections to FY21 Actual]

	FY2021 Projections		FY2021 Actual		Y on Y Change	
	(B JPY)	(%)	(B JPY)	(%)	(B JPY)	(%)
Net sales	1,770.0	100.0	1,812.5	100.0	+42.5	+2.4
Operating income	410.0	23.2	424.1	23.4	+14.1	+3.4
Income before income taxes	416.0	23.5	432.7	23.9	+16.7	+4.0
Net income attributable to Murata Corporation	302.0	17.1	314.1	17.3	+12.2	+4.0

Breakdown of Operating Income Changes [FY21 Projection to FY21 Actual]

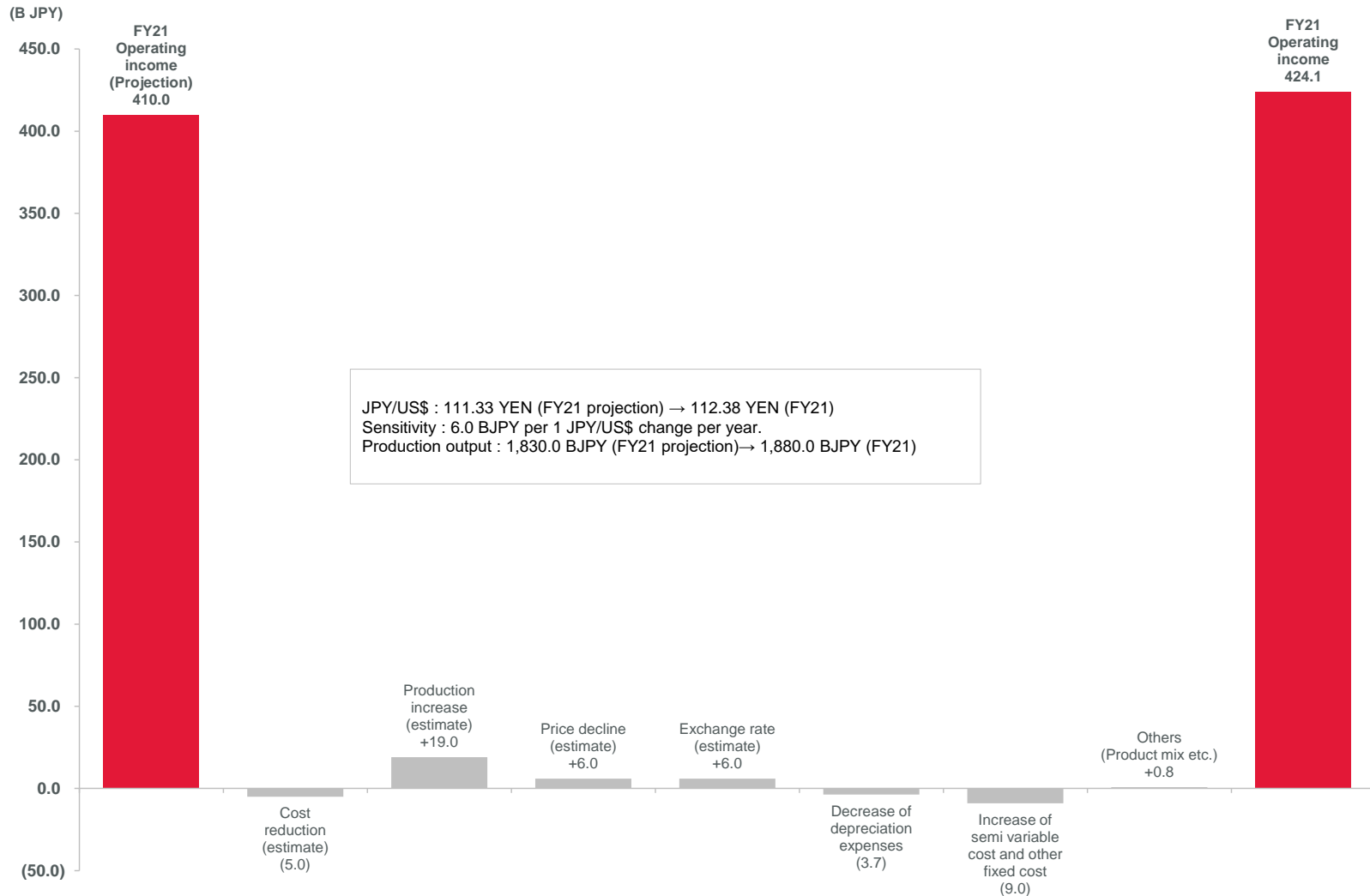

*“Production increase” is calculated on the basis of production output excluding the effect of sales price reductions and exchange rate fluctuations.

*Changes in semi-variable costs and fixed costs include the impact of temporary expenses, such.

Financial Results Overview

[FY22 1st Half Projections to FY22 2nd Half Projections]

	FY2022 1st Half Projections		FY2022 2nd Half Projections		H on H Change	
	(B JPY)	(%)	(B JPY)	(%)	(B JPY)	(%)
Net sales	952.0	100.0	978.0	100.0	+26.0	+2.7
Operating income	209.0	22.0	231.0	23.6	+22.0	+10.5
Income before income taxes	210.0	22.1	232.0	23.7	+22.0	+10.5
Net income attributable to Murata Corporation	154.0	16.2	170.0	17.4	+16.0	+10.4

Breakdown of Operating Income Changes [FY22 1st Half Projection to FY22 2nd Half Projection]

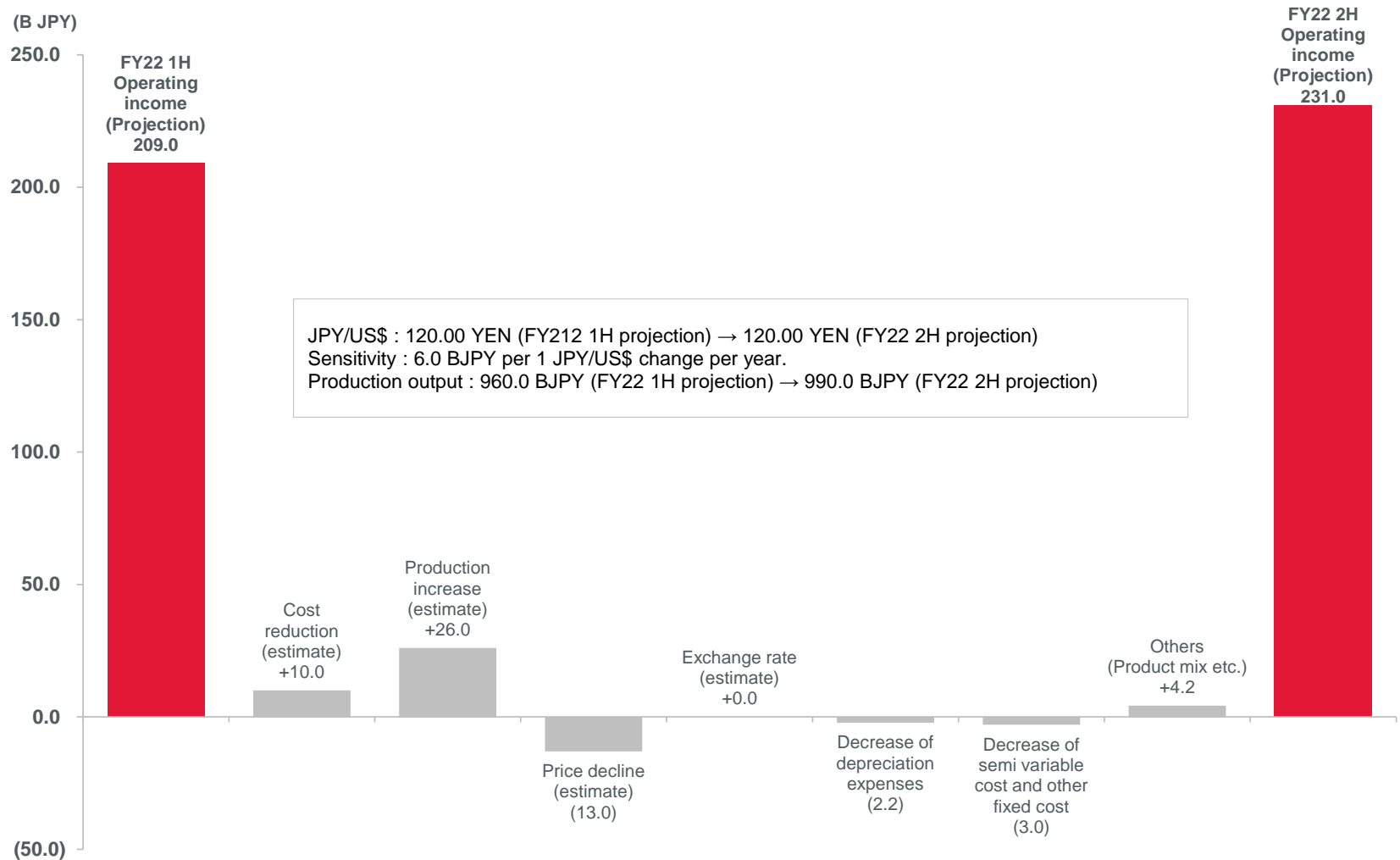

*“Production increase” is calculated on the basis of production output excluding the effect of sales price reductions and exchange rate fluctuations.

Financial Data (1/4)

(B JPY)

	FY2019				FY2020				FY2021			
	1Q	2Q	3Q	4Q	1Q	2Q	3Q	4Q	1Q	2Q	3Q	4Q
Sales	357.6	403.4	410.2	362.9	326.8	425.2	468.6	409.5	439.6	468.5	471.4	433.1
Operating income	62.6	58.8	79.5	52.4	51.3	80.2	108.4	73.3	105.1	117.0	113.9	88.0
Income before income taxes	63.2	61.6	78.0	51.3	53.9	79.2	106.3	76.9	103.7	124.1	115.0	89.8
Net income attributable to Murata Corporation	46.8	43.9	56.1	36.2	39.6	60.3	76.5	60.7	77.2	90.6	82.6	63.7
Capital expenditures	52.9	62.0	81.4	85.4	40.2	43.8	48.9	63.9	42.6	32.1	33.4	44.7
Depreciation and amortization	33.6	34.6	35.7	36.4	34.0	35.9	35.7	37.5	37.3	38.7	39.6	40.0
R & D expenses	26.1	25.3	24.7	26.4	24.8	26.2	24.4	26.3	27.0	27.2	28.2	28.9
Average exchange rates (yen)	109.90	107.35	108.76	108.97	107.62	106.22	104.51	105.90	109.49	110.11	113.71	116.21

Financial Data (2/4)

(B JPY)

		FY2019				FY2020				FY2021			
		1Q	2Q	3Q	4Q	1Q	2Q	3Q	4Q	1Q	2Q	3Q	4Q
Sales by Product	Capacitors	137.7	137.8	145.7	138.2	134.5	156.1	167.3	168.7	189.3	202.4	200.6	192.9
	Piezoelectric Components	31.4	31.9	33.6	32.3	26.4	34.4	32.0	36.6	38.8	37.6	33.4	28.6
	Other Components	92.4	98.6	92.8	79.2	77.4	101.3	107.0	102.0	110.9	121.0	121.2	107.3
	Components	261.5	268.3	272.2	249.8	238.2	291.8	306.2	307.2	339.0	360.9	355.3	328.9
	Modules	95.2	134.3	137.0	112.1	87.9	132.8	161.8	101.6	99.9	106.9	115.2	103.6
	Net sales	356.7	402.5	409.2	361.9	326.2	424.5	468.0	408.9	438.8	467.8	470.5	432.5
Sales by Application	AV	16.9	17.7	14.8	11.6	15.4	20.7	18.4	17.3	19.0	20.6	16.6	15.3
	Communication	163.9	212.1	226.1	190.0	159.2	222.1	247.7	175.9	185.7	207.1	210.4	176.1
	Computers and Peripherals	58.6	60.6	58.1	53.2	68.0	71.3	74.5	77.7	89.7	93.1	92.5	85.1
	Automotive Electronics	66.8	66.1	66.2	64.4	42.8	66.4	80.0	83.9	82.7	82.1	80.3	91.2
	Home Electronics and Others	50.6	46.0	43.9	42.6	40.7	44.0	47.3	54.0	61.8	64.9	70.8	64.7
	Net sales	356.7	402.5	409.2	361.9	326.2	424.5	468.0	408.9	438.8	467.8	470.5	432.5
Sales by Product	The Americas	47.2	57.9	45.8	38.7	28.6	48.7	55.2	38.0	45.6	58.6	52.9	48.7
	Europe	36.1	31.7	30.4	33.8	21.2	31.8	35.0	38.3	40.4	40.3	40.7	41.1
	Greater China	172.7	208.1	237.2	192.1	198.8	244.1	276.4	231.8	245.0	256.9	263.1	228.9
	Asia and Others	63.0	69.6	60.8	64.6	48.7	67.7	62.8	62.9	68.4	69.4	70.6	74.6
	Overseas total	319.0	367.3	374.3	329.3	297.2	392.3	429.5	371.0	399.4	425.2	427.3	393.2
	Japan	37.8	35.3	34.9	32.6	28.9	32.2	38.5	37.8	39.4	42.6	43.2	39.3
Net sales	356.7	402.5	409.2	361.9	326.2	424.5	468.0	408.9	438.8	467.8	470.5	432.5	

Financial Data (3/4)

(B JPY)

		FY2019				FY2020				FY2021			
		1Q	2Q	3Q	4Q	1Q	2Q	3Q	4Q	1Q	2Q	3Q	4Q
Components	Total revenue	271.7	278.8	285.2	262.5	245.6	300.8	315.0	314.0	346.1	370.1	363.9	336.5
	Segment income	67.5	50.1	68.9	63.1	58.9	79.2	91.4	83.5	112.0	121.7	120.1	98.8
Modules	Total revenue	95.2	134.3	137.0	112.1	87.9	132.8	161.8	101.6	99.9	106.9	115.2	103.6
	Segment income	7.9	17.9	21.9	1.7	6.9	14.8	32.9	(0.4)	8.5	11.0	11.1	7.9
Others	Total revenue	16.9	15.4	14.0	12.9	14.4	16.8	15.1	14.7	15.6	15.5	14.8	15.4
	Segment income	1.5	1.6	1.2	1.5	1.9	2.0	1.9	1.9	2.0	2.0	1.6	1.3
Corporate and eliminations	Total revenue	(26.4)	(25.1)	(26.0)	(24.7)	(21.1)	(25.2)	(23.3)	(20.8)	(22.0)	(23.9)	(22.6)	(22.4)
	Corporate expenses	(14.3)	(10.8)	(12.5)	(13.9)	(16.4)	(15.9)	(17.9)	(11.7)	(17.5)	(17.6)	(18.9)	(20.0)
Consolidated	Total revenue	357.6	403.4	410.2	362.9	326.8	425.2	468.6	409.5	439.6	468.5	471.4	433.1
	Operating income	62.6	58.8	79.5	52.4	51.3	80.2	108.4	73.3	105.1	117.0	113.9	88.0

Financial Data (4/4)

(B JPY)

		FY2021			
		1Q	2Q	3Q	4Q
Sales by Product	Capacitors	190.0	203.4	201.4	193.8
	Inductors and EMI filters	49.3	51.9	51.1	43.5
	Components	239.3	255.2	252.5	237.3
	High-Frequency Device and Communications Module	128.3	137.4	140.2	122.4
	Battery and Power supply	42.6	45.3	48.8	43.7
	Functional Device	26.7	27.7	26.3	25.6
	Devices/Module	197.6	210.3	215.3	191.8
	Others	1.9	2.3	2.7	3.4
	Net sales	438.8	467.8	470.5	432.5
	Sales by Application	Communication	185.7	207.1	210.4
Mobility		82.7	82.1	80.3	91.2
Computers		74.6	77.0	75.1	70.7
Home Electronics		44.2	48.3	47.1	43.7
Industry and Others		51.6	53.4	57.7	50.7
Net sales		438.8	467.8	470.5	432.5

muRata
INNOVATOR IN ELECTRONICS